

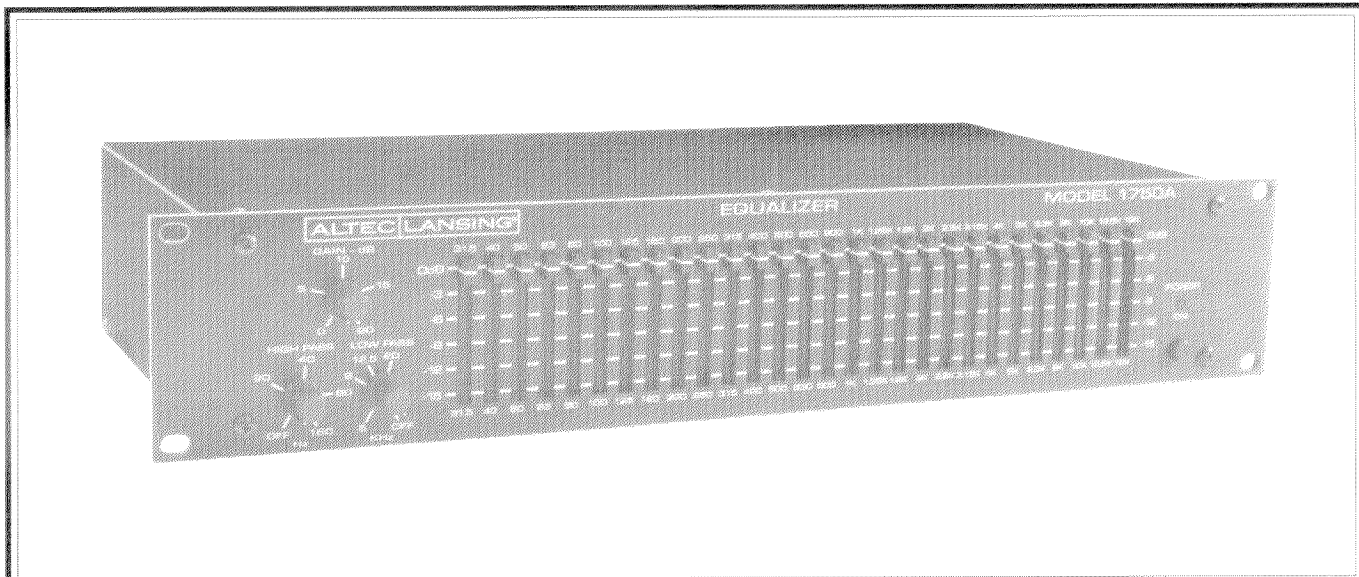

# 1750A 28 Band 1/3 Octave Equalizer



- ★ Constant-Q Active Band-Rejection Filters
- ★ Adjustable High- and Low-Pass Filters
- ★ Electronically Balanced Input & Output
- ★ 28 Band Cut

## KEY SPECIFICATIONS

<b>Type:</b>	Active filter set with 28 constant-Q minimum phase shift band-rejection filters at ISO preferred 1/3 octave center frequencies.
<b>Frequency Response:</b> (reference 1 kHz)	20 Hz to 20 kHz, + 0/-1 dB.
<b>THD:</b> (0 dBm output, unity gain)	<0.03%.
<b>IMD (SMPTE):</b> (0 dBm output, unity gain)	<0.03%.
<b>Noise:</b> (unity gain, unweighted)	>-82 dBm.
<b>Dynamic Range:</b>	>110 dB.
<b>Load Impedance:</b>	600 ohms or higher.
<b>Operating Gain:</b>	0 dB.
<b>Available Gain:</b> (to restore equalization losses).	20 dB

## DESCRIPTION

In the tradition of striving for the highest quality and reliability, Altec Lansing introduces the **1750A** Equalizer backed by a vast knowledge of equalization technology. The **1750A** is designed to provide cost-effective accurate control for the custom tailoring of frequency response in any professional or industrial application.

The **1750A** features 28 constant-Q active band-rejection filters at the ISO preferred 1/3 octave center frequencies from 31.5 Hz to 16 kHz. Each filter section provides up to 15 dB of attenuation at its center frequency and is designed to skirt with adjacent filters for minimum ripple and optimum combining characteristics over a wide range of control settings. A 20 dB gain control is provided to restore equalization losses.

The variable high-pass filter, with a slope of 18 dB per octave, allows adjustment of the system's lower cutoff frequency from below 20 Hz to 160 Hz. The variable low-pass filter also has a slope of 18 dB per octave and can operate from 5 kHz to above 20 kHz, providing a smooth high-end roll off. Other features include an automatic AC dropout bypass, output muting that suppresses turn on/off transients, XLR and barrier strip input and output connectors, and electronically balanced input and output circuitry. The universal power transformer permits 100, 120, 200, 220, 240 Vac, 50/60 Hz operation. In case of AC power loss, the capability of silently switching to DC battery power is provided by a barrier strip connector on the rear of the chassis. There are two optional plug-in isolation transformers available: the **15550A** input transformer and the **15560A** output transformer.

The Altec Lansing Model **1750A** Equalizer is the choice among professionals where precision room equalization is required.

## SPECIFICATIONS (continued)

### Input:

(reference 0 dBv = 0.775 Vrms)

Type: Electronically balanced.  
 Impedance: 30 kohms balanced.  
 15 kohms unbalanced.  
 Nominal level: 0 dBv (0.775 Vrms).  
 Maximum Level: +24 dBv (12.3 Vrms)

### Power requirements:

AC: 100, 120, 200, 220, 240 Vac, 50/60 Hz, 10 Watts.  
 DC: Bipolar 24/28 Vdc at 200 mA (auto-matic transfer to DC mode if AC power fails)

### Output:

(reference 0 dBm = 0.775 Vrms across 600 ohms)

Type: Electronically balanced.  
 Impedance: 44 ohms balanced.  
 22 ohms unbalanced.  
 Maximum level: +24 dBm.

### Operating Temperature Range:

Up to 60°C (140°F).

### Dimensions:

Height: 3.5 inches (8.9 cm).  
 Width: 19.0 inches (48.3 cm).  
 Depth: 9.75 inches (24.8 cm).

### High-Pass Filter:

Variable low frequency cutoff from below 20 Hz to 160 Hz with slope of 18 dB per octave.

### Weight:

Net: 10.7 lbs (4.9 kgs).  
 Shipping: 13.2 lbs (6.0 kgs).

### Low-Pass Filter:

Variable high frequency cutoff from 5 kHz to above 20 kHz with slope of 18 dB per octave.

### Enclosure:

Rack-mount chassis.  
 18 GA steel main chassis.  
 18 GA steel top, sides, rear cover.  
 3/16 inch (0.5 cm) aluminum front panel

### Controls:

28 slide controls at 1/3 octave ISO center frequencies from 31.5 Hz to 16 kHz, -15 dB cut.  
 Gain, High-pass filter and Low-pass filter controls.  
 AC power switch (bypasses 1750A when shut off).

### Color:

Black.

### Accessories:

**10402** Perforated Security Cover.  
**15550A** Input Isolation Transformer.  
**15560A** Output Isolation Transformer.

### Connections:

Input: Female XLR.  
 Barrier strip.  
 Output: Male XLR.  
 Barrier strip.  
 AC power: IEC power cord receptacle.  
 DC power: Barrier strip.

Altec Lansing continually strives to improve its products and their performance. Therefore, specifications are subject to change without any advance notice.

## Block Diagram of 1750A

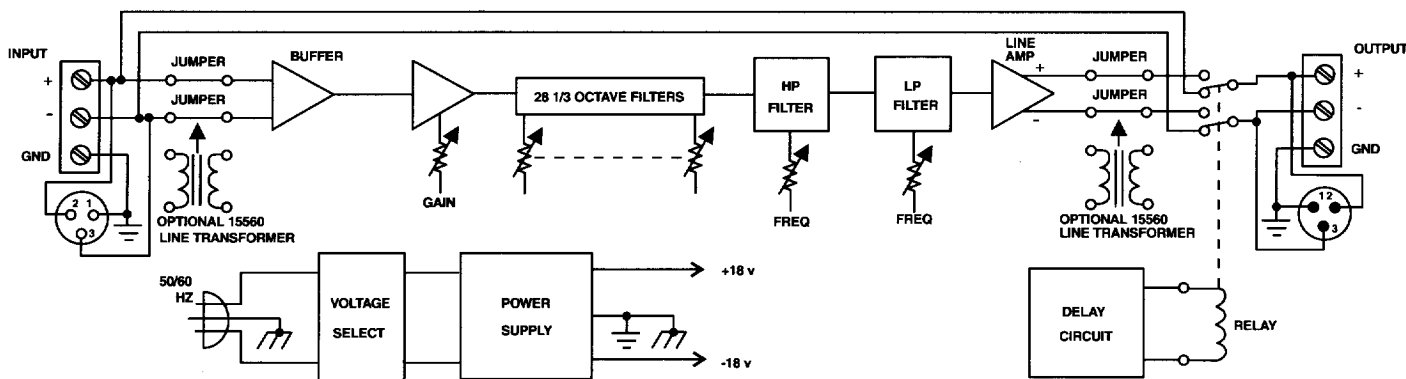

# Typical Response Curves for the 1750A

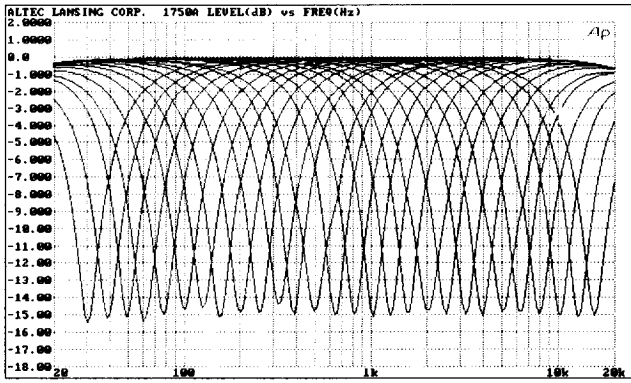

28 1/3-Octave Filters at Maximum Attenuation (-15 dB). Plotted Individually.

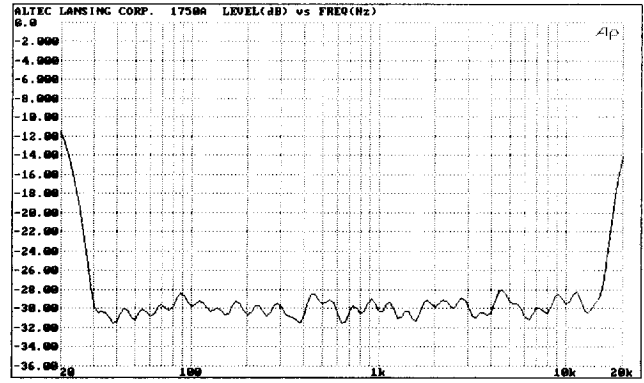

All Filters at Full Attenuation.

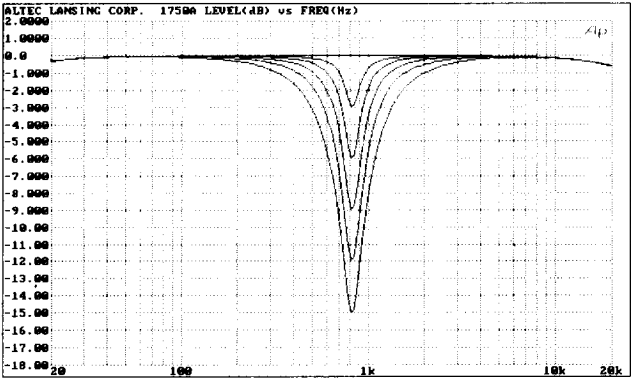

Single Filter, 800 Hz, Shown at Each Front Panel Setting.

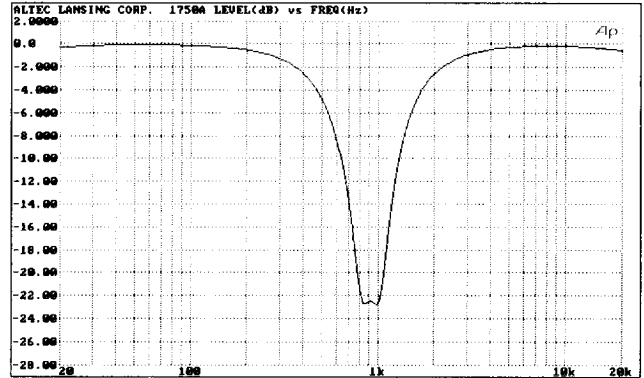

Two Adjacent Filters, 800 Hz and 1 kHz, at Full Attenuation.

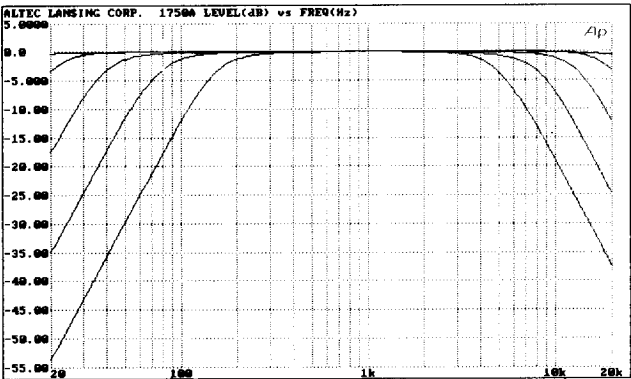

High- and Low-Pass Functions (18 dB/oct) Plotted Individually.

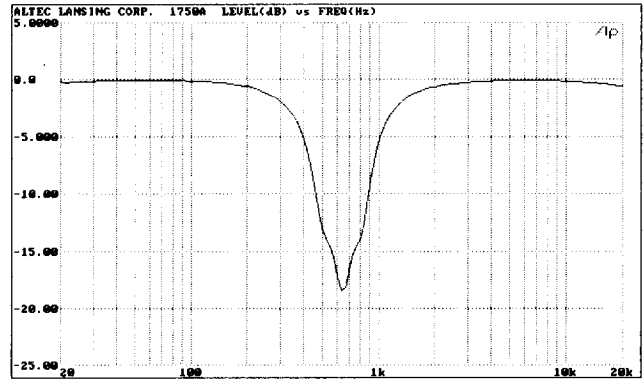

630 Hz Filter at -15 dB, 500 Hz and 800 Hz Filters at -6 dB.

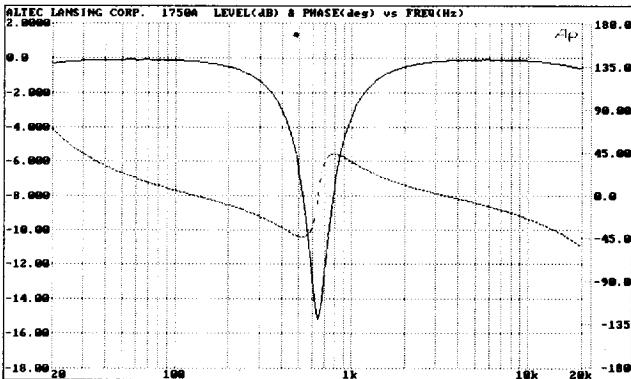

630 Hz Filter at Full Attenuation and Phase Angle (deg) Vs Frequency (Hz)

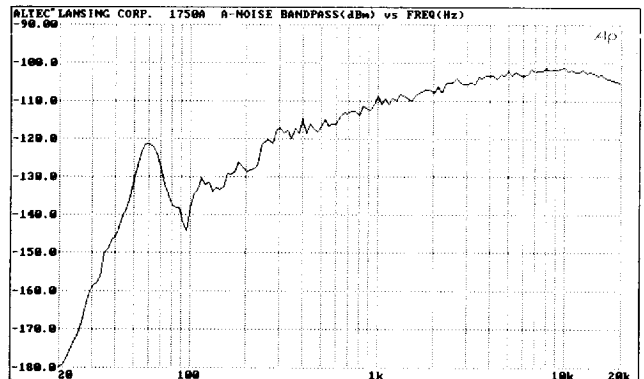

A-Weighted Noise (dBm) Vs Frequency (Hz)

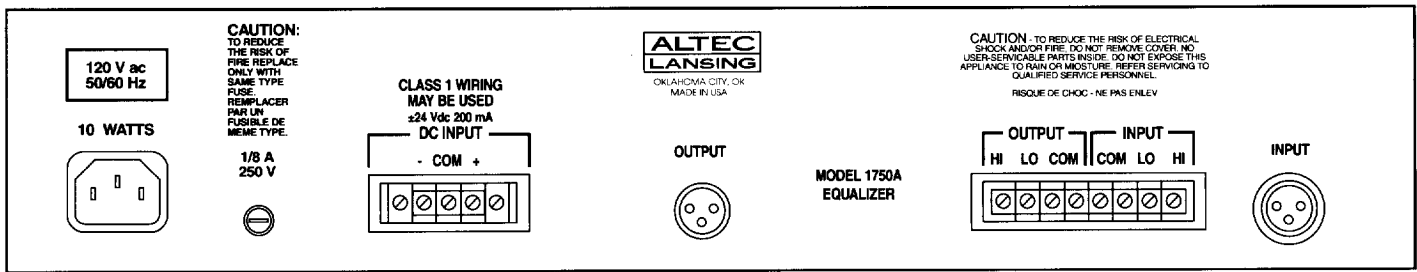

## 1750A Rear Panel Layout

### ARCHITECT'S and ENGINEER'S SPECIFICATIONS

The equalizer shall contain 28 constant-Q active band-rejection filters at the ISO preferred 1/3 octave center frequencies from 31.5 Hz to 16 kHz. Each filter shall provide up to 15 dB of attenuation at its center frequency and shall be designed to skirt with adjacent filters for minimum ripple and optimum combining characteristics over a wide range of control settings. The amount of cut shall be controlled by linear slide type controls. A front panel rotary control shall provide 20 dB of gain to restore equalization losses. The equalizer shall also contain 18 dB/octave high-pass and low-pass filters with continuously variable cutoff frequency points adjustable from below 20 Hz to 160 Hz for the high-pass and 5 kHz to above 20 kHz for the low-pass. These cutoff frequency points shall be adjusted with front panel rotary controls.

The input and output shall be electronically balanced, and the output shall be capable of driving a load of 600 ohms or higher. An optional plug-in line transformer shall be available for input and output. The unit shall contain an automatic AC power dropout bypass and output muting that suppresses turn on/off transients. Barrier strip and XLR connectors shall be provided for input and output signal wiring. The unit shall provide a front panel power switch with

an LED indicator showing Power On status. The equalizer shall have a universal transformer that permits 100, 120, 200, 220, 240 Vac, 50/60 Hz operation. It shall also have the capability of silently switching to DC battery power in case of AC power loss.

The equalizer shall meet the following criteria. Maximum input level: +24 dBv (12.3 Vrms). Nominal input level: 0 dBv (0.775 Vrms). Input impedance: 30 kohms balanced and 15 kohms unbalanced. Maximum output level: +24 dBm. Output impedance: 44 ohms balanced, 22 ohms unbalanced. Frequency response: 20 Hz to 20 kHz, + 0/- 1 dB referenced at 1 kHz. Operating gain: 0 dB. Dynamic Range: greater than 110 dB. THD: less than 0.03% with 0 dBm output at unity gain. IMD (SMPTE): less than 0.03% with 0 dBm output at unity gain. Noise: less than -82 dBm A-weighted at unity gain.

The equalizer shall be enclosed in a black 18 GA steel rack mountable chassis with a 3/16 inch (0.5 cm) aluminum front panel. The dimensions shall be 3.5 inches (8.9 cm) high by 19.0 inches (48.3 cm) wide by 9.75 inches (24.8 cm) deep and shall have a net weight of 10.7 lbs. (4.9 kgs). An optional security cover shall also be available.

The equalizer shall be called the Altec Lansing **1750A**.



a MARK IV company

P.O. BOX 26105 • OKLAHOMA CITY, OK 73126-0105 • U.S.A.

Phone: 405/324-5311 or FAX: 405/324-8981

© 1994 ALTEC LANSING CORPORATION

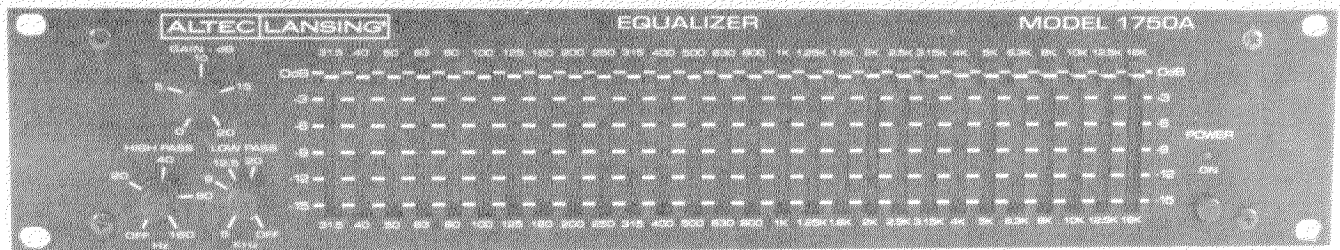

**DESCRIPTION**

In the tradition of striving for the highest quality and reliability, ALTEC LANSING introduces the 1750A Equalizer backed by a vast knowledge of equalization technology. The 1750A is designed to provide cost-effective accurate control for the custom tailoring of frequency response in any professional or industrial application.

The 1750A features 28 constant-Q active band-rejection filters at the ISO preferred 1/3 octave center frequencies from 31.5 Hz to 16 kHz. Each filter section provides up to 15 dB of attenuation at its center frequency and is designed to skirt with adjacent filters for minimum ripple and optimum combining characteristics over a wide range of control settings. A 20 dB gain control is provided to restore equalization losses.

The variable high-pass filter, with a slope of 18 dB per octave, allows adjustment of the system's lower cutoff frequency from below 20 Hz to 160

Hz. The variable low-pass filter also has a slope of 18 dB per octave and can operate from 5 kHz to above 20 kHz, providing a smooth high-end roll off.

Other features include an automatic ac dropout bypass, output muting that suppresses turn on/off transients, XLR and barrier strip input and output connectors, and electronically balanced input and output circuitry. The universal power transformer permits 100, 120, 200, 220, 240 Vac, 50/60 Hz operation. In case of ac power loss, the capability of silently switching to dc battery power is provided by a barrier strip connector on the rear of the chassis. An optional plug-in line transformer, Model 15560A, is also available for input and output.

The ALTEC LANSING Model 1750A Equalizer is the choice among professionals where precision room equalization is required.

## SPECIFICATIONS

**Type:** Active filter set with 28 constant-Q minimum phase shift band-rejection filters at ISO preferred 1/3 octave center frequencies.

### Input

(reference 0 dBv = 0.775 Vrms):

**Type:** Electronically balanced

**Impedance:** 30 k $\Omega$  balanced  
15 k $\Omega$  unbalanced

**Nominal Level:** 0 dBv (0.775 Vrms)

**Maximum Level:** +24 dBv (12.3 Vrms)

### Output

(reference 0 dBm = 0.775 Vrms across 600 $\Omega$ ):

**Type:** Electronically balanced

**Impedance:** 44 $\Omega$  balanced  
22 $\Omega$  unbalanced

**Maximum Level:** +24 dBm

**Load Impedance:** 600 ohms or higher

### Frequency Response

(reference 1 kHz): 20 Hz — 20 kHz +0, -1 dB

**Operating Gain:** 0 dB

**Available Gain:** 20 dB (to restore equalization losses)

**Dynamic Range:** >110 dB

**High-Pass Filter:** Variable low frequency cutoff from below 20 Hz to 160 Hz with slope of 18 dB per octave

**Low-Pass Filter:** Variable high frequency cutoff from 5 kHz to above 20 kHz with slope of 18 dB per octave

### THD

(0 dBm output, unity gain): <0.03%

### IMD (SMPTE)

(0 dBm output, unity gain): <0.03%

### Noise

(unity gain, A-weighted): < -90 dBm

**Controls:** 28 slide controls at 1/3 octave ISO center frequencies from 31.5 Hz to 16 kHz, -15 dB cut  
Gain control  
High-pass filter control  
Low-pass filter control  
AC power switch (bypasses 1750A when shut off)

### Connections:

**Input:** Female XLR  
Barrier strip

**Output:** Male XLR  
Barrier strip

**AC power:** IEC power cord receptacle

**DC power:** Barrier strip

### Power Requirements:

**AC:** 100, 120, 200, 220, 240 Vac, 50/60 Hz, 10 Watts

**DC:** Bipolar 24/28 Vdc at 200 mA (automatic transfer to dc mode if ac power fails)

### Operating Temperature Range:

up to 60° C (140° F)

### Dimensions:

3.50" (8.89 cm) H  $\times$  19" (48.26 cm) W  $\times$  9.75" (24.75 cm) D

### Shipping Weight:

13.2 lbs (6.00 kg)

### Net Weight:

10.7 lbs (4.90 kg)

### Enclosure:

Rack mount chassis  
18 GA steel main chassis  
18 GA steel top/sides/rear cover  
3/16 inch aluminum front panel

### Color:

Black

### Accessories:

Optional 16 GA perforated steel security cover  
15560A line transformer

Altec Lansing continually strives to improve their products and performance. Therefore specifications are subject to change without notice.

# 1750A TYPICAL PERFORMANCE CURVES

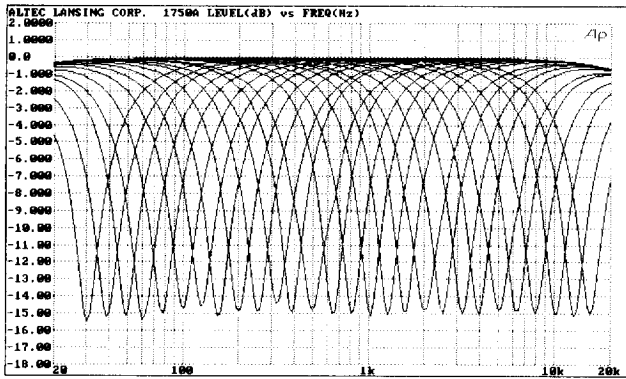

28  $\frac{1}{3}$  Octave Filters at Maximum Attenuation (-15 dB). Each Independently Plotted

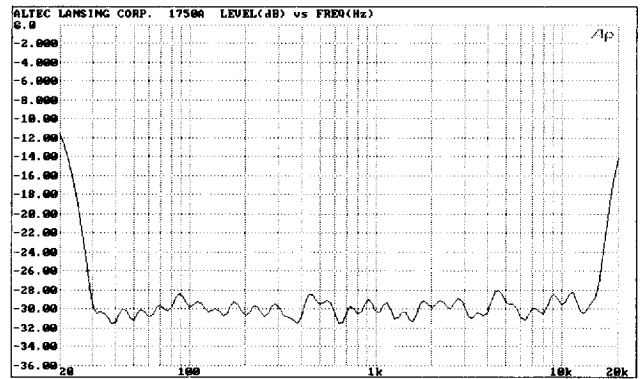

All Filters Set at Full Attenuation

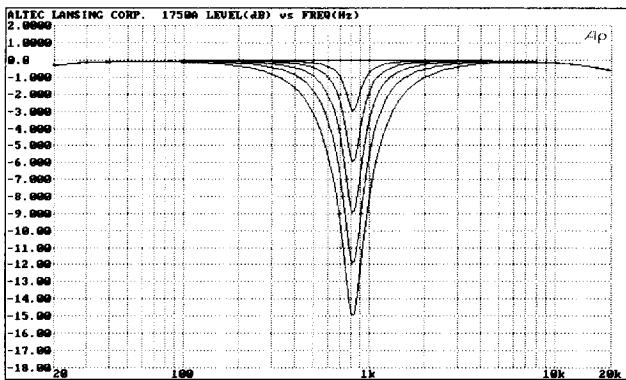

Single Filter, 800 Hz, Shown at Each Front Panel Setting

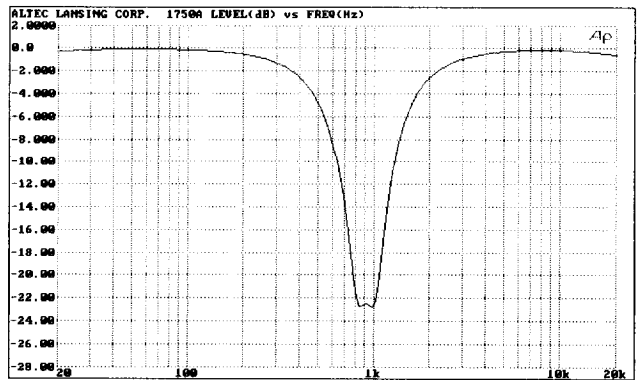

Two Adjacent Filters, 800 Hz and 1 kHz, Set at Full Attenuation

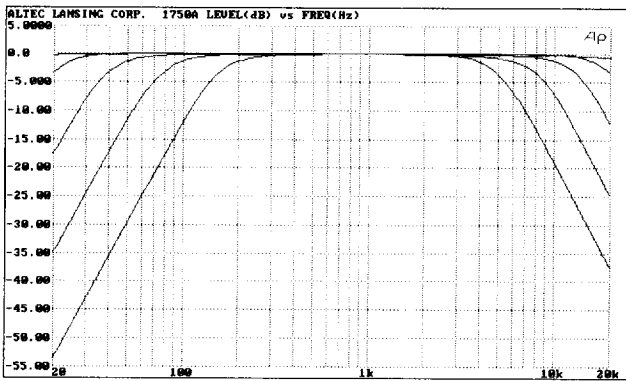

High-Pass and Low-Pass Functions (18 dB/oct) Independently Plotted

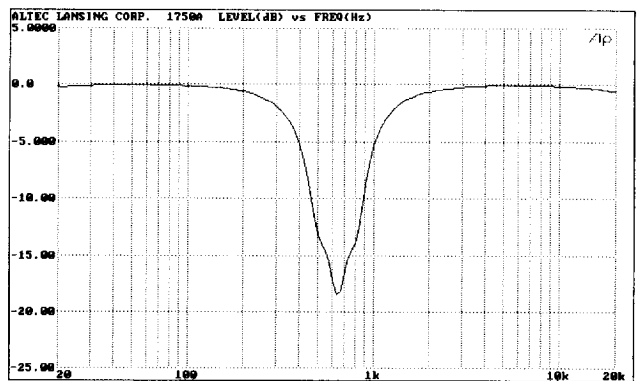

630 Hz Filter Set at -15 dB, 500 Hz and 800 Hz Filters Set at -6 dB

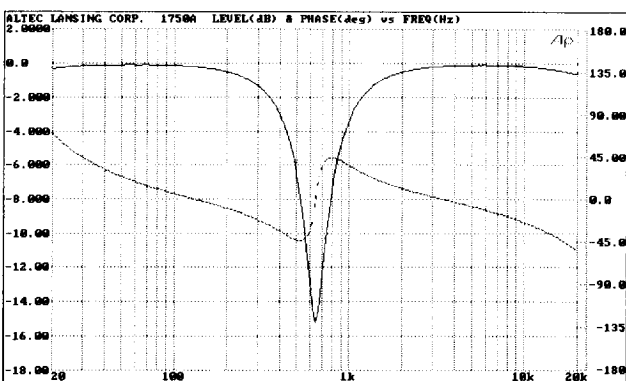

630 Hz Filter at Full Attenuation and Phase Angle (deg) vs Frequency (Hz)

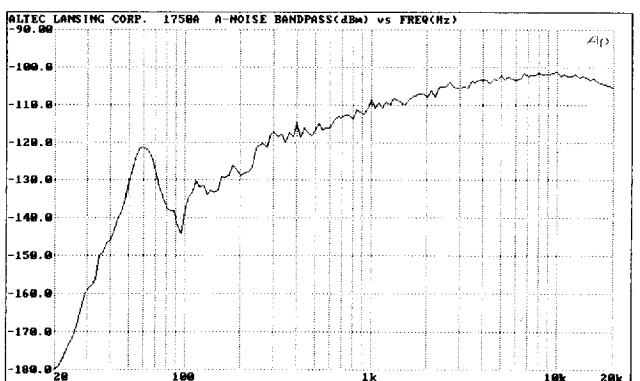

A-weighted Noise (dBm) vs Frequency (Hz)

## ARCHITECT'S AND ENGINEER'S SPECIFICATIONS

The equalizer shall contain 28 constant-Q active band-rejection filters at the ISO preferred  $\frac{1}{3}$  octave center frequencies from 31.5 Hz to 16 kHz. Each filter shall provide up to 15 dB of attenuation at its center frequency and shall be designed to skirt with adjacent filters for minimum ripple and optimum combining characteristics over a wide range of control settings. The amount of cut shall be controlled by linear slide type controls. A front panel rotary control shall provide 20 dB of gain to restore equalization losses. The equalizer shall also contain 18 dB/octave high-pass and low-pass filters with continuously variable cutoff frequency points adjustable from below 20 Hz to 160 Hz for the high-pass and 5 kHz to above 20 kHz for the low-pass. These cutoff frequency points shall be adjusted with front panel rotary controls.

The input and output shall be electronically balanced, and the output shall be capable of driving a load of 600 ohms or higher.

An optional plug-in line transformer shall be available for input and output.

The unit shall contain an automatic ac power dropout bypass and output muting that suppresses turn on/off transients.

Barrier strip and XLR connectors shall be provided for input and output signal wiring.

The unit shall provide a front panel power switch with an LED indicator showing Power On status.

The equalizer shall have a universal transformer that permits 100, 120, 200, 220, 240 Vac, 50/60 Hz operation. It shall also have the capability of silently switching to dc battery power in case of ac power loss.

The equalizer shall meet the following criteria. Maximum input level: +24 dBv (12.3 Vrms). Nominal input level: 0 dBv (0.775 Vrms). Input impedance: 30 kohms balanced and 15 kohms unbalanced. Maximum output level: +24 dBm. Output impedance: 44 ohms balanced, 22 ohms unbalanced. Frequency response: 20 Hz – 20 kHz, +0, –1 dB referenced at 1 kHz. Operating gain: 0 dB. Dynamic Range: greater than 110 dB. THD: less than 0.03% with 0 dBm output at unity gain. IMD (SMPTE): less than 0.03% with 0 dBm output at unity gain. Noise: less than –90 dBm A-weighted at unity gain.

The equalizer shall be enclosed in a black 18 GA steel rack mountable chassis with a  $\frac{3}{16}$  inch aluminum front panel. It shall be 3.50" H  $\times$  19" W  $\times$  9.75" D and shall have a net weight of 10.7 lbs. An optional security cover shall also be available.

The equalizer shall be called the ALTEC LANSING 1750A.



P.O. BOX 26105, OKLAHOMA CITY, OK 73126-0105, U.S.A.

© 1988 ALTEC LANSING CORPORATION



**OPERATING INSTRUCTIONS**

**ELECTRICAL**

**120 Vac, 50/60 Hz Power Connections**

The 1750A is provided for 120 Volts from the factory. Refer to Table I for exact strapping details and other voltage options.

**NOTE**

Verify that the line voltage is in accordance with the selected voltage rating **BEFORE** connecting the 1750A to the power line.

Table I. Primary Power Conversion Chart

VOLTAGE	CONNECT PINS
100 V	1-5, 2-4
120 V	1-6, 3-4
200 V	2-5
220 V	2-6
240 V	3-6

**100, 200, 220, 240 Vac, 50/60 Hz Power Connections**

The 1750A may be powered from line voltages other than 120 Volts by re-strapping the primary of the power transformer. Use the following procedures to change the factory strapping to the desired line voltage.

1. Disconnect the 1750A from the AC power source.
2. Remove the twelve screws securing the top cover.
3. Locate and remove the two screws that secure the transformer shield and remove shield. Locate the six voltage selection solder cups above the power transformer. See Figure 1 for location.

4. Referring to Table I, unsolder the jumper wires from the solder cups and resolder them in accordance with the pin designations that correspond to the desired operating voltage.
5. Install the transformer shield with the two screws previously removed.
6. Install the appropriate fuse value from Table II below. **Use of fuses other than those listed below will void the warranty.**
7. Install the top cover with the twelve screws previously removed.

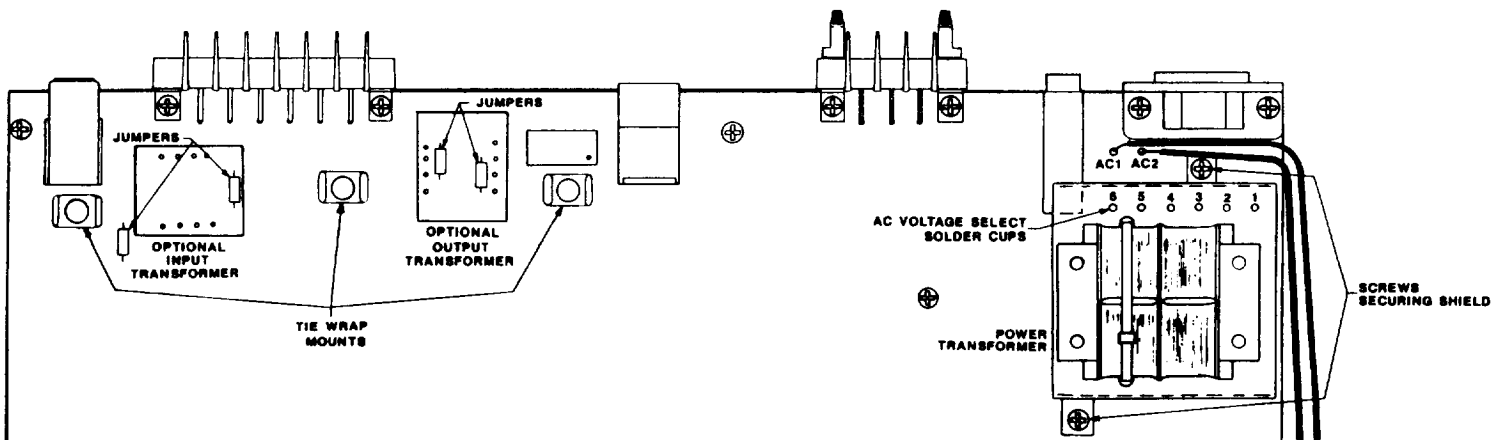

Figure 1. Location of Pertinent Components on Circuit Board.

Table II. Fuse Selection Chart

AC Line Voltage	AC Line Fuse (Type 3AG Slo-Blo)
100 V	1/8 Amp/250 V
120 V	1/8 Amp/250 V
200 V	1/16 Amp/250 V
220 V	1/16 Amp/250 V
240 V	1/16 Amp/250 V

**NOTE**

If configuring the 1750A for a line voltage other than 120 Volts, affix the proper voltage rating label near the power cord connector to cover the 120 VAC silkscreened designation. These labels are taped to the top of the chassis. Replace the line fuse according to Table II.

**Battery Operation**

The 1750A is operable from bipolar 24 Vdc and requires 200 mAdc. Connect the battery backup system to the 3-terminal barrier strip located on the rear of the equalizer as shown in Figure 2.

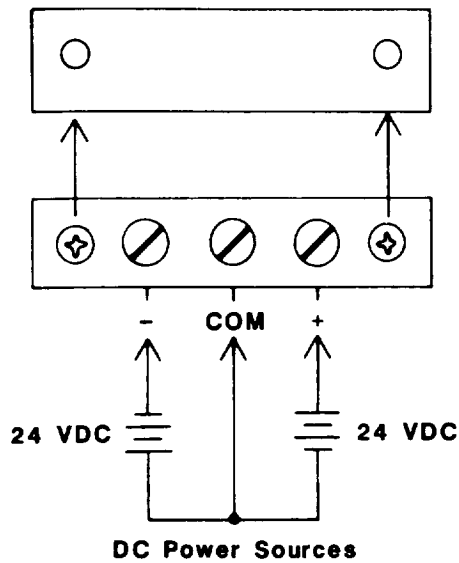

**Step ①**  
Remove Black Plastic Cover.

**Step ②**  
Connect DC Power Sources as Shown.

**Step ③**  
Re-Install Black Plastic Protective Cover.

Figure 2. Battery Input Connections.

Two battery power fuses are located on the circuit board inside the chassis. One fuse protects the (+) power line and the other protects the (-) power line of the unit. To replace either fuse, follow these procedures.

1. Disconnect the 1750A from all power sources.
2. Remove the twelve screws that secure the top cover.
3. Locate the 1 Amp fuses on the main circuit board.

4. Replace ONLY with identical 1 Amp (Type 3AG) fuse.
5. Replace cover with the twelve screws previously removed.

**INSTALLATION**

**Rack Mounting**

The 1750A may be installed in a standard 19-inch equipment rack. The equalizer requires 3.50 inches (2 Rack units) of vertical space and mounting is accomplished by using the appropriate four screws supplied.

**Ventilation**

The 1750A should not be used in areas where the ambient temperature exceeds 60° C (140° F).

**SIGNAL CONNECTIONS**

**Input Connections**

Balanced input connections may be made either to the input barrier strip or to the 3-pin female XLR connector. For single-ended inputs, strap the low (-) input to ground. Refer to Figure 3 for typical input connections.

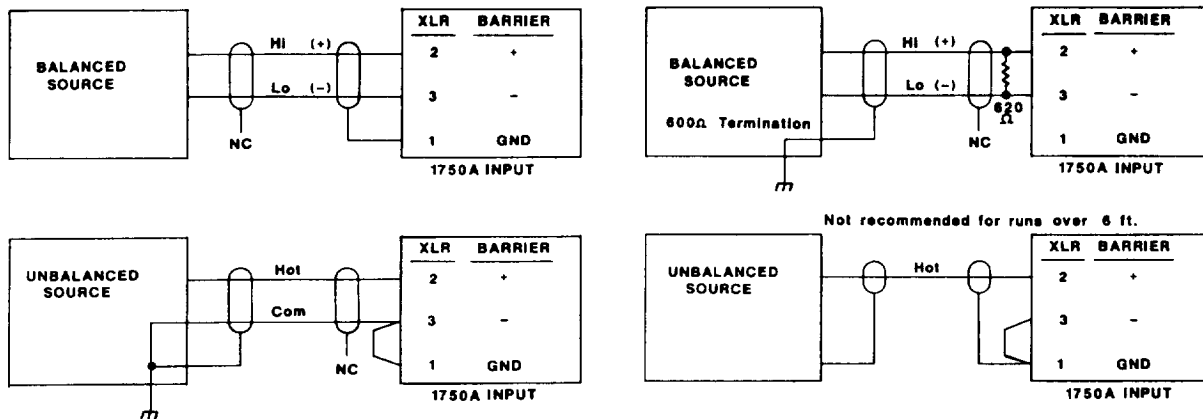

Figure 3. Typical Input Connections

## Output Connections

Balanced output connections are made either to the output barrier strip or to the 3-pin male XLR connector.

### CAUTION

The 1750A's electronically balanced output is ground referenced. DO NOT OPERATE WITH THE HIGH (+) OR LOW (-) SIGNAL OUTPUT CONNECTED TO GROUND. If operated in this manner an internal component failure could result.

Unbalanced loads may be connected between either the high (+) or low (-) signal output and ground. If the load is connected between the low (-) output and ground, a 180° phase shift will occur between the input and output signals. Unbalanced loads connected as described above will experience a 6 dB loss in output signal. This loss may be made up by using the GAIN control or by installing the optional output transformer described below. Refer to Figure 4 for typical output connection details.

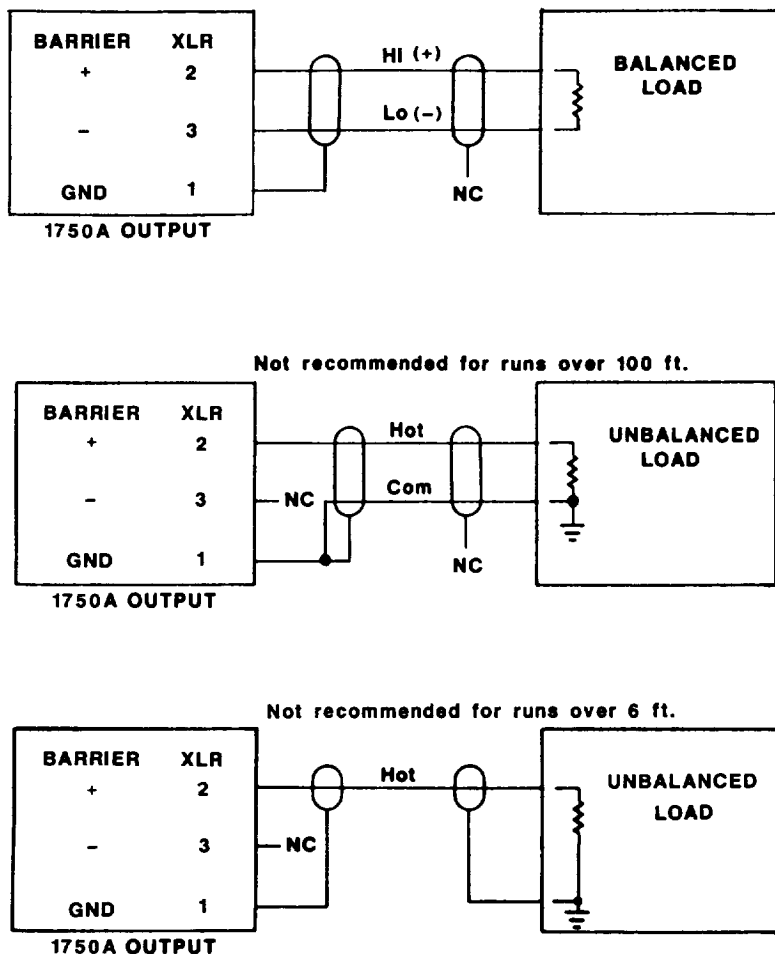

Figure 4. Typical Output Connections.

## INSTALLING OPTIONAL INPUT AND OUTPUT LINE TRANSFORMERS

The Model 15560A line transformer is available to provide isolation for the input and the output, if necessary. The circuit board is drilled to accept the 15560A. It is recommended that the 15560A line transformer be added ONLY when isolation is needed, for it will slightly increase low frequency distortion. Use the following procedures to install the 15560A line transformer.

1. Disconnect the 1750A from the AC power supply.
2. Remove the twelve screws securing the top cover.
3. Locate the transformer mounting areas near the top of the circuit board. See Figure 1 for exact locations.
4. Cut two jumpers for each transformer installed. These jumpers are indicated in Figure 1.
5. Insert the transformer into the pin receptacles inside its desired mounting area. (The orientation of the pin receptacles is keyed so that the transformer can be inserted only one way.)
6. Install the tie wrap that is included with the 15560A transformer as shown in Figure 5.
7. Install the top cover with the twelve screws previously removed.

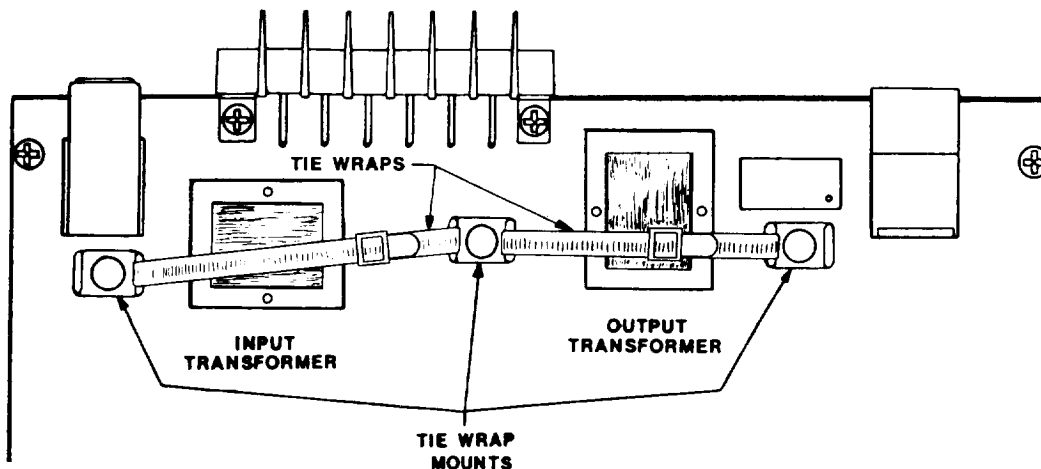

Figure 5. Installation of 15560A Transformer Tie Wraps.

## OPERATION

1. After the 1750A is properly installed, set the signal level at the CHANNEL INPUT to the desired level.
2. Set the filter controls to obtain the desired frequency response over the audio spectrum.
3. Adjust the GAIN control to provide an equalized output level equal to that of the unequalized input level.

### NOTE

**The GAIN control is to be used ONLY to make up for equalization losses.**

4. If desired, record filter control settings on a chart similar to that shown in Figure 6.

**ALTEC LANSING**

**EQUALIZER**

**MODEL 1750A**

GAIN - dB 31.5 40 50 63 80 100 125 160 200 250 315 400 500 630 800 1K 1.25K 1.6K 2K 2.5K 3.15K 4K 5K 6.3K 8K 10K 12.5K 16K

5 -15 0dB

10 15

-3

20

-6

HIGH PASS LOW PASS

POWER

40

-9

20 8 12.5 20

ON

-80

-12

OFF 160 5 OFF

-15

Hz

31.5 40 50 63 80 100 125 160 200 250 315 400 500 630 800 1K 1.25K 1.6K 2K 2.5K 3.15K 4K 5K 6.3K 8K 10K 12.5K 16K

KHz

Figure 6. Control Settings Record.

Table III. Controls and Features

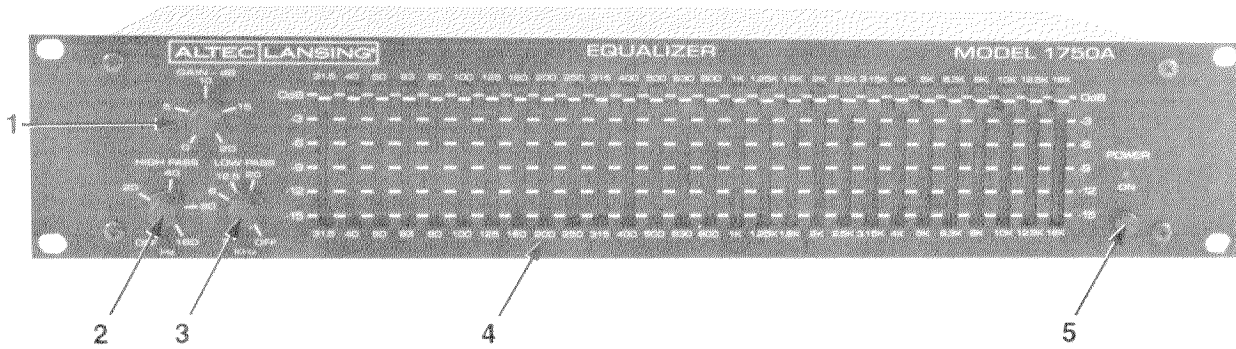

ITEM	NAME	FUNCTION/DESCRIPTION
1	GAIN Control	Adjusts output level of equalized program to match input level of unequalized program. Maximum available gain is 20 dB.
2	HIGH PASS Filter Control	Adjusts high pass filter to shape low-frequency portion of audio spectrum. Continuously variable rotary control provides roll off at 18 dB/octave from below 20 Hz to 160 Hz.
3	LOW PASS Filter Control	Adjusts low pass filter to shape high-frequency portion of audio spectrum. Continuously variable rotary control provides roll off at 18 dB/octave from 5 kHz to above 20 kHz.
4	Filter Controls	Adjust $\frac{1}{3}$ octave constant-Q active filters. Twenty-eight linear slide controls are provided at ISO preferred center frequencies from 31.5 Hz to 16 kHz. Control range is 0 to 15 dB cut on each center frequency with 3 dB calibration marks on the front panel.
5	POWER Switch and Indicator	Depressing this switch applies primary AC power. The LED above this switch illuminates when power is turned on.

Table IV. Rear Panel Controls and Features

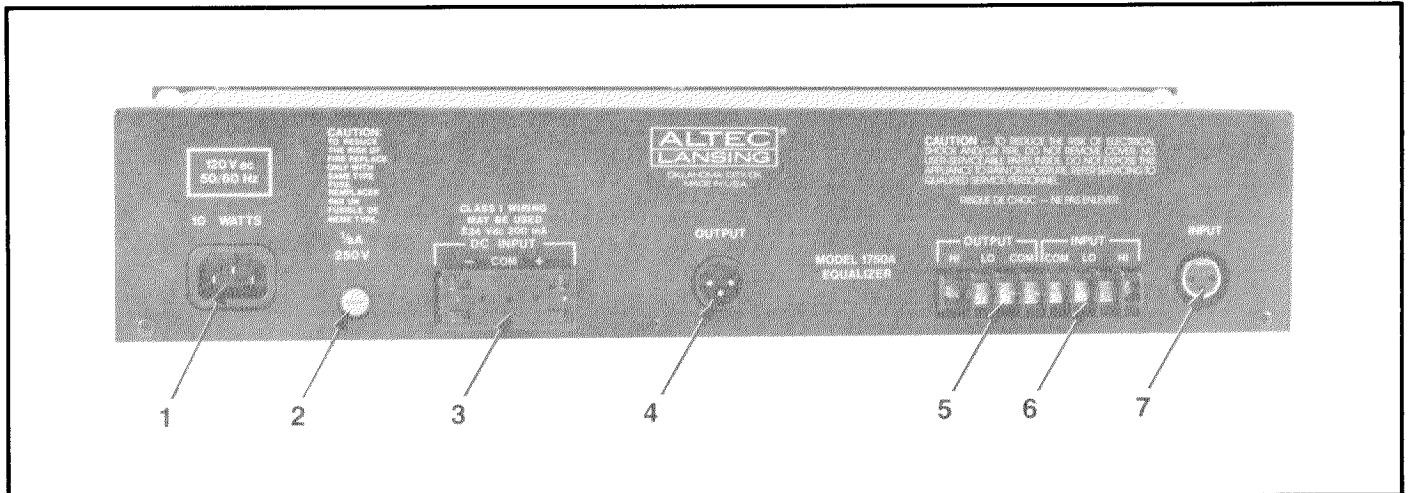

ITEM	NAME	FUNCTION/DESCRIPTION
1	Primary Power Connector	AC line voltage is applied through this connector.
2	Fuse	Protects against excessive current drain from AC power source.
3	BATTERY Connector	Connect external battery power supply for auxiliary operation or standby. Requires bipolar 24 Vdc power source. See Figure 2.
4	OUTPUT Connector	Provides connection to balanced or unbalanced 600Ω load. Male 3-pin XLR output connector.
5	OUTPUT Terminals	Screw terminals for connection to balanced or unbalanced 600Ω load.
6	INPUT Terminals	Screw terminals for connection to balanced or unbalanced input.
7	INPUT Connector	Provides connection to balanced or unbalanced input. Female 3-pin XLR input connector.

## **1750A EQUALIZER**

### **SERVICE INSTRUCTIONS**

#### **\* \* \* CAUTION \* \* \***

**No user serviceable parts inside. Hazardous voltages and currents be encountered within the chassis. The service information contained within this document is for use only by ALTEC LANSING Corp. authorized warranty stations and qualified service personnel. To avoid electric shock, DO NOT perform any servicing other than that contained in the Operating Instructions unless you are qualified to do so. Refer all servicing to qualified service personnel.**



## 1750A SERVICE INSTRUCTIONS

Customer modifications to ALTEC LANSING products are not recommended. Such modifications shall be at the customer's sole expense, and any damage or injury to persons or property resulting therefrom shall not be covered under warranty or otherwise.

**NOTICE**

**REPAIR PERFORMED BY OTHER THAN AUTHORIZED WARRANTY STATIONS (DEALERS) OR QUALIFIED PERSONNEL SHALL VOID THE WARRANTY PERIOD OF THIS UNIT.**

### Zero Gain Trim Adjustment

The following procedures are recommended.

1. Verify that the GAIN control is fully counterclockwise and that all sliders are in the maximum UP position.
2. Apply power and input a 1 kHz sine wave signal at 0 dBv (0.775 Vrms) to the input connector. Measure the output voltage across a 600 ohm load and verify 0 dBm (0.775 Vrms) at the output. If the output is not 0 dBm (0.775 Vrms) proceed to step 3.

Otherwise, the Zero Gain Trim is adjusted correctly.

3. Verify that power is off. Remove the twelve screws securing the top cover.
4. Apply power and input a 1 kHz sine wave signal at 0 dBv (0.775 Vrms) to the input connector.
5. Connect a balanced AC voltmeter across the output connector. Carefully adjust R7 (see Figure 1 for exact location) for an output reading of 0 dBm (0.775 Vrms across 600 ohms).
6. Turn power off and install the top cover with the twelve screws previously removed.

### SERVICE INFORMATION

#### Parts Ordering

To order replacements parts, look up the ordering number from the parts list and call (405) 324-5311, Telex 160369, or write:

ALTEC LANSING Replacement Parts Service  
P.O. Box 26105  
Oklahoma City, OK 73126-0105 U.S.A.

### Factory Service

If factory service is required, ship the unit pre-paid to:

ALTEC LANSING Customer Service/Repair  
10500 West Reno Avenue  
Oklahoma City, OK 73128 U.S.A.

Enclose a written note describing the problem along with any other helpful information such as where used, how used, etc.

### Technical Assistance

For applications assistance or other technical information, call (405) 324-5311, Telex 16069, or write:

ALTEC LANSING Technical Assistance  
P.O. Box 26105  
Oklahoma City, OK 73126-0105 U.S.A.

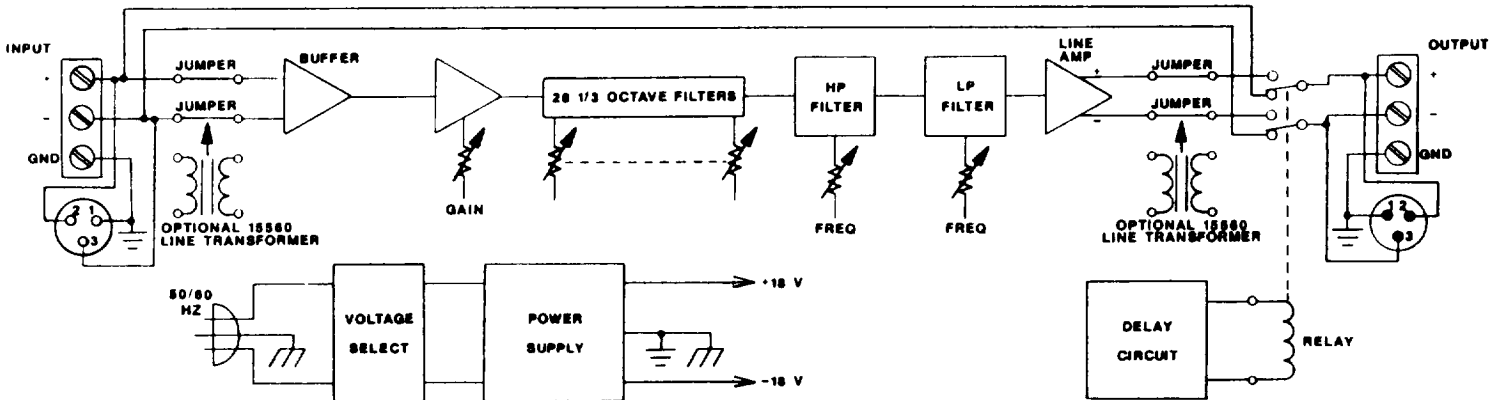

Figure 7. Block Diagram of the 1750A

PARTS LIST

MAIN PCB ASSEMBLY (27-01-026032)

Reference Designator	Ordering Number	Name and Description
C1, 2, 4, 5, 6, 7	15-06-124440	Cap., 100 pF, 630 V
C3	15-06-124610	Cap., 330 pF, 630 V
C8-12, 36-40	15-06-124643	Cap., .33 μF, 5% 100 V
C13-25, 41-53	15-06-124637	Cap., .1 μF, 5%, 100 V
C26-35, 54-63	15-06-124588	Cap., .01 μF, 5%, 100 V
C64, 65, 66	15-06-122844	Cap., .68 μF, 5%, 63-100 V
C67, 68, 69	15-06-122838	Cap., .0015 μF, 5%, 100-630 V
C70	15-01-124591	Cap., 220 μF, 50 V
C71-80, 107, 108	15-01-124502	Cap., 10 μF, 50 V
C81-104	15-02-124437	Cap., .1 μF, 50 V, disk
C105, 106	15-01-124505	Cap., 1000 μF, 50 V
C109	15-01-124504	Cap., 22 μF, 50 V
C110	15-01-124503	Cap., 100 μF, 50 V
CR1-8, 11	48-02-024787	Rect., 1N4004
CR9, 10	48-01-122601	Diode, signal, 1N4448
CR12	39-01-124540	LED, Red, w/ 12" leads
CR13, 14	48-01-124636	Diode, zener, 3.0 V
F1	51-04-121511	Fuse, 1/8 A, 250 V, SB
F2, 3	51-04-100465	Fuse, 1 A, 250 V, NB
K1	45-01-123000	Relay, 12 V, 1 A, DPDT
Q1	48-03-120159	Transistor, MPSU10, NPN, 300V
R1-4	47-03-124484	Res., 15.0 kΩ, 1%, 1/4 W
R5	47-03-124484	Res., 6.34 kΩ, 1%, 1/4 W
R6, 35, 45, 193, 194	47-03-109437	Res., 10.0 kΩ, 1%, 1/4 W
R7	47-07-025647	Pot., 10 kΩ, 30%, trim
R8, 17	47-03-124640	Res., 3.40 kΩ, 1%, 1/4 W
R9-16, 55, 65	47-03-123344	Res., 4.87 kΩ, 1%, 1/4 W
R18	47-03-124666	Res., 154 kΩ, 1%, 1/4 W
R19	47-03-124665	Res., 121 kΩ, 1%, 1/4 W
R20	47-03-124664	Res., 97.6 kΩ, 1%, 1/4 W
R21	47-03-124623	Res., 76.8 kΩ, 1%, 1/4 W
R22	47-03-119034	Res., 61.9 kΩ, 1%, 1/4 W
R23	47-03-123012	Res., 158 kΩ, 1%, 1/4 W
R24	47-03-124662	Res., 127 kΩ, 1%, 1/4 W
R25	47-03-119305	Res., 100 kΩ, 1%, 1/4 W
R26, 36	47-03-124661	Res., 80.6 kΩ, 1%, 1/4 W
R27, 37	47-03-124680	Res., 63.4 kΩ, 1%, 1/4 W
R28, 38	47-03-124659	Res., 51.1 kΩ, 1%, 1/4 W
R29, 39	47-03-109430	Res., 40.2 kΩ, 1%, 1/4 W
R30, 40	47-03-124489	Res., 31.6 kΩ, 1%, 1/4 W
R31, 41	47-03-124658	Res., 25.5 kΩ, 1%, 1/4 W
R32, 42	47-03-109434	Res., 20.0 kΩ, 1%, 1/4 W
R33, 43	47-03-124728	Res., 15.8 kΩ, 1%, 1/4 W
R34, 44	47-03-124679	Res., 12.7 kΩ, 1%, 1/4 W
R46	47-03-124614	Res., 11.8 kΩ, 1%, 1/4 W
R47	47-03-124683	Res., 9.31 kΩ, 1%, 1/4 W
R48	47-03-124682	Res., 7.32 kΩ, 1%, 1/4 W
R49	47-03-124726	Res., 5.90 kΩ, 1%, 1/4 W
R50	47-03-124684	Res., 4.64 kΩ, 1%, 1/4 W
R51	47-03-124685	Res., 12.1 kΩ, 1%, 1/4 W
R52	47-03-124686	Res., 9.53 kΩ, 1%, 1/4 W
R53	47-03-119021	Res., 7.68 kΩ, 1%, 1/4 W

Reference Designator	Ordering Number	Name and Description
R54, 64	47-03-124673	Res., 6.19 kΩ, 1%, 1/4 W
R56, 66	47-03-119016	Res., 3.83 kΩ, 1%, 1/4 W
R57, 67	47-03-124670	Res., 3.09 kΩ, 1%, 1/4 W
R58, 68	47-03-124677	Res., 2.43 kΩ, 1%, 1/4 W
R59, 69	47-03-121330	Res., 1.91 kΩ, 1%, 1/4 W
R60, 70	47-03-124669	Res., 1.50 kΩ, 1%, 1/4 W
R61, 71	47-03-124676	Res., 1.21 kΩ, 1%, 1/4 W
R62, 72	47-03-124675	Res., 953Ω, 1%, 1/4 W
R63, 73	47-03-124674	Res., 768Ω, 1%, 1/4 W
R74	47-03-123304	Res., 22.1 kΩ, 1%, 1/4 W
R75	47-03-119026	Res., 17.4 kΩ, 1%, 1/4 W
R76	47-03-122854	Res., 13.7 kΩ, 1%, 1/4 W
R77	47-03-124552	Res., 11.0 kΩ, 1%, 1/4 W
R78	47-03-124667	Res., 8.66 kΩ, 1%, 1/4 W
R79	47-03-124657	Res., 22.6 kΩ, 1%, 1/4 W
R80	47-03-124724	Res., 17.8 kΩ, 1%, 1/4 W
R81	47-03-124656	Res., 14.3 kΩ, 1%, 1/4 W
R82, 92	47-03-124655	Res., 11.3 kΩ, 1%, 1/4 W
R83, 93	47-03-124727	Res., 9.09 kΩ, 1%, 1/4 W
R84, 94	47-03-124653	Res., 7.15 kΩ, 1%, 1/4 W
R85, 95	47-03-123020	Res., 5.76 kΩ, 1%, 1/4 W
R86, 96	47-03-124725	Res., 4.42 kΩ, 1%, 1/4 W
R87, 97	47-03-124651	Res., 3.57 kΩ, 1%, 1/4 W
R88, 98	47-03-124647	Res., 2.80 kΩ, 1%, 1/4 W
R89, 99	47-03-124649	Res., 2.26 kΩ, 1%, 1/4 W
R90, 100	47-03-124648	Res., 1.78 kΩ, 1%, 1/4 W
R91, 101	47-03-124645	Res., 1.43 kΩ, 1%, 1/4 W
R102-185	47-03-121532	Res., 1.00 kΩ, 1%, 1/4 W
R186, 187, 188	47-03-124594	Res., 1.47 kΩ, 1%, 1/4 W
R189, 190, 191	47-03-108443	Res., 1.21 kΩ, 1%, 1/4 W
R192	47-01-102127	Res., 100 kΩ, 5%, 1/4 W
R195, 196	47-01-102038	Res., 22Ω, 5%, 1/4 W
R197, 198, 200, 201, 202	47-01-102106	Res., 15 kΩ, 5%, 1/4 W
R199	47-01-113206	Res., 5.6 MΩ, 5%, 1/4 W
R203	47-01-107373	Res., 10 MΩ, 5%, 1/4 W
R204	47-01-102086	Res., 2.2 kΩ, 5%, 1/4 W
R205	47-01-102061	Res., 200Ω, 5%, 1/4 W
R206	47-01-102082	Res., 1.5 kΩ, 5%, 1/4 W
R329	47-06-124715	Pot., 20 kΩ, 3-ganged, Rev. H
R330	47-06-124713	Pot., 20 kΩ, 3-ganged, Rev. J
S1	51-02-124478	Switch, PB, power, DPDT
T1	56-08-025906	Transformer, power
U1, 11, 12	17-01-122832	IC, 5532A dual op-amp
U2-10	17-01-124583	IC, UPC4574 quad op-amp
U13	17-01-121660	IC, regulator, + 15V, MC7815CT
U14	17-01-121659	IC, regulator, - 15V, MC7915CT

CONTROL PCB ASSEMBLY (27-01-026031)

Reference Designator	Ordering Number	Name and Description
R301-328	47-06-124702	Pot., 5 kΩ, slider, linear

MAIN CHASSIS

Reference Designator	Ordering Number	Name and Description
R331	47-06-124714	Pot., 20 kΩ, linear

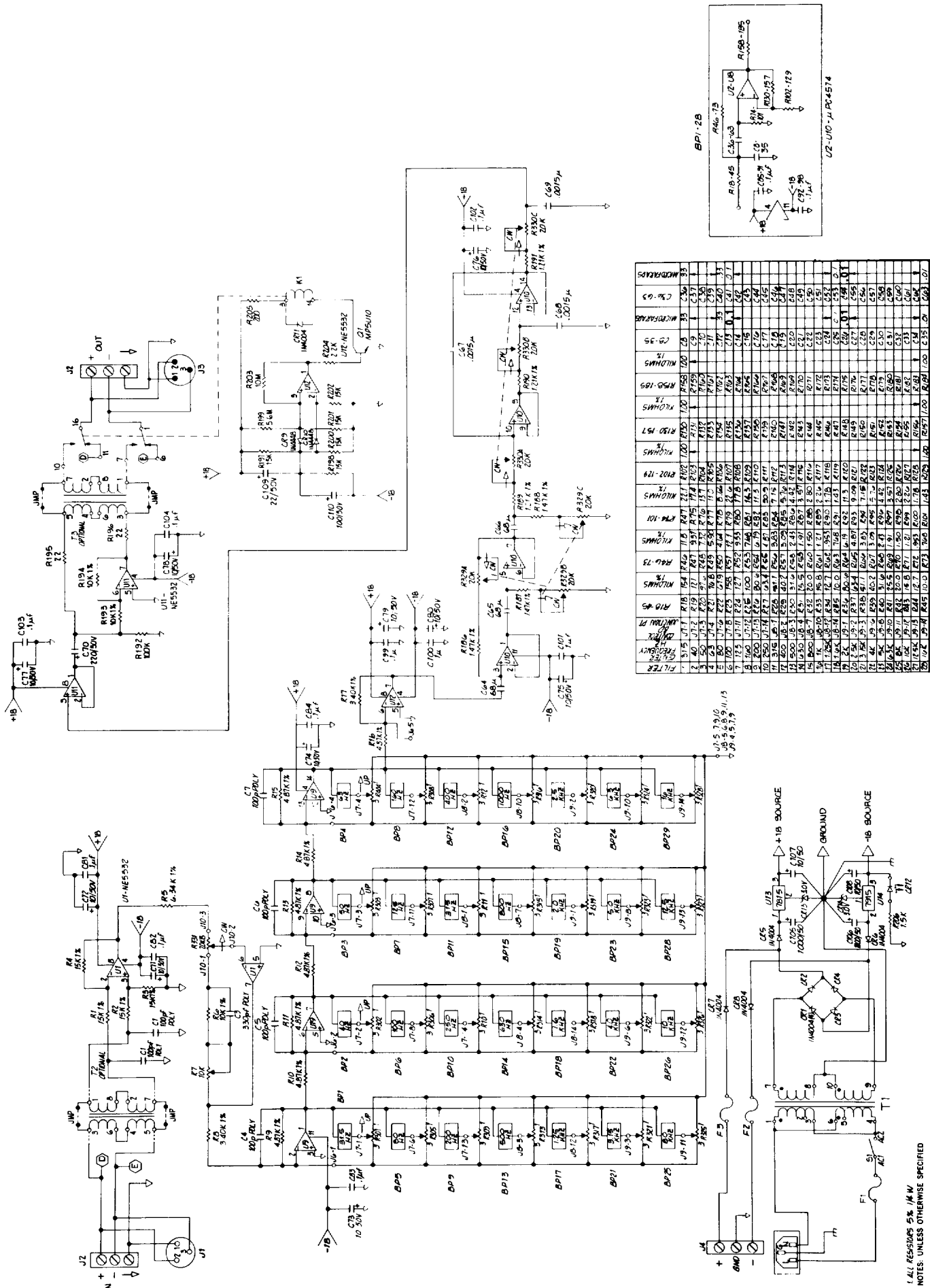

Figure 8. Schematic Drawing of 1750A Equalizer (11D193-01)

1. ALL RESISTORS 5% 1/4 W.  
 NOTES: UNLESS OTHERWISE SPECIFIED